

## 1. INTRODUCTION

The Digy Elite is a vandal resistant keypad access control unit suitable for external applications. The unit accepts up to 500 users and provides entry via the use of PIN codes. Model Digy Elite is provided with LED backlight.

## 2. MAIN TECHNICAL FEATURES

**Operating Voltage Range:** 12-24 VAC/DC

**Maximum Input Current:**

without heating:	20 mA in standby -- 115 mA max
with backlight (Digy Elite only):	50mA in standby -- 145mA max
with heating, 12Vcc:	520mA in standby – 615 mA max
with heating, 24Vcc:	350mA in standby – 465 mA max

**Lock Strike Relay:** Form C, 2A

**Auxiliary Relay:** Form C, 2A

**Inputs:**

REX	N.O., Dry Contact
Auxiliary Input (In / Monitor)	N.C., Dry Contact in Monitor Mode N.O., Dry Contact in Input Mode

**Operating Temperature:**

Keypad Heater Enabled: da –20 °C a 63 °C

Keypad Heater Disabled: da 0 °C a 63 °C

**IP protection degree:** IP 65

**Dimensions:** 120mm x 76mm x 21mm

**Weight:** 410 g

## 3. MOUNTING

Before starting, select the location to mount the Digy Elite controller. This location should be at shoulder height and on the same side as the door handle. For fixing, drill two holes, in correspondence of the two points marked as A.

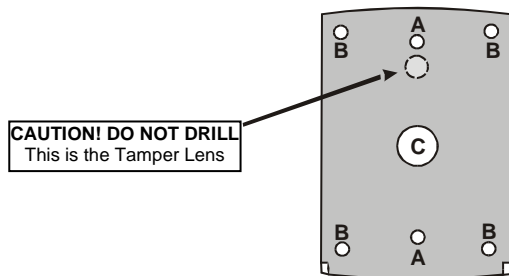

Drill in correspondence of sign C for the passage of cables.

1. Wire the controller according to the wiring instructions on the following page.
2. Screw the Digy Elite back cover to its mounting location.
3. Return the front cover of the Digy Elite to the mounted back plate.
4. Secure the front cover by using the supplied security screw in the Installation Kit. An L-Shaped tool is provided for use when tightening the security screw.

### 3.1 Wiring the Digy Elite

The controller is supplied with a 1 m pigtail, having a 10 conductor cable. To wire the Digy Elite, perform the following steps.

1. Prepare the controller cable to the required length.

Splice the controller pigtail wires to the corresponding devices and cover each connection. Refer to the wire color guide provided below and to the wiring diagrams provided on the following pages.

COLOR	DESCRIPTION
RED	V INPUT
BLACK	GROUND
GREEN	REX / BL
WHITE	IN / MONITOR
PURPLE	LOCK: COM
GRAY	N.O.
BROWN	N.C.
BLUE	AUX: COM
YELLOW	N.O.
ORANGE	N.C.

3) Trim and cover all conductors that are not used.

Two typical wiring diagrams are shown on the next pages.

### 3.2 Wiring the Lock Strike Relay and REX

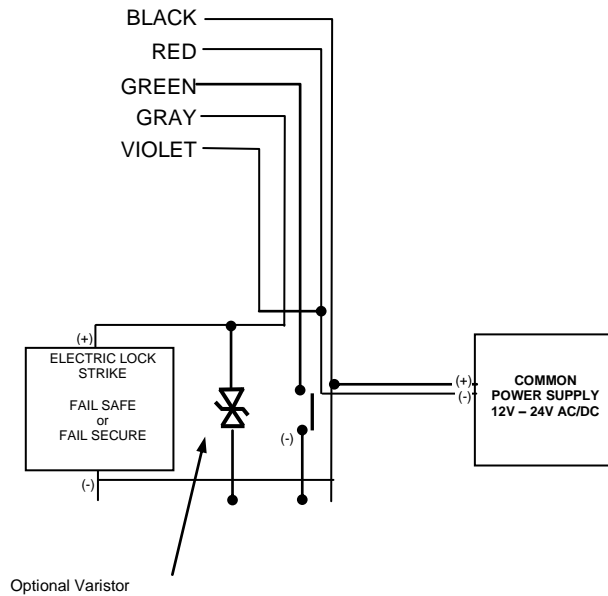

### 3.3 Wiring the Auxiliary Input and Output

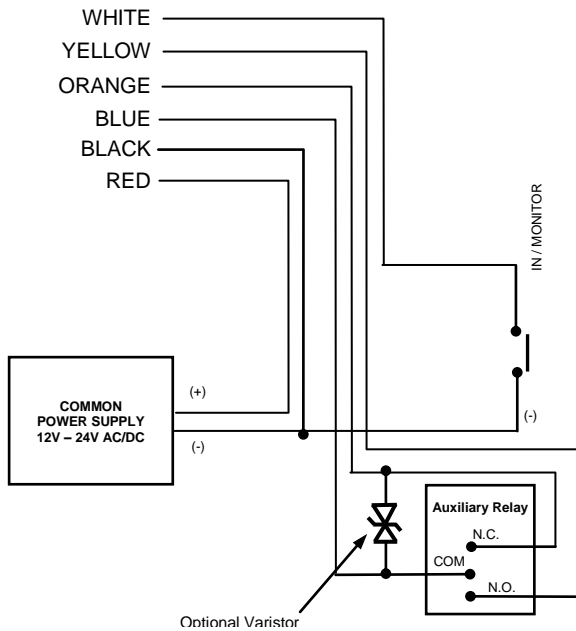

## 4. NORMAL, SECURE & MASTER USERS

The Digy Elite accepts up to 500 users and provides entry via the use of PIN codes. Each user is provided with two code memory slots, Memory Slot 1 (Primary Code) and Memory Slot 2 (Secondary Code). The way in which the two memory slots are programmed determines a users access level and also determines the way in which the Digy Elite grants access in its three Modes of Operation. There are three user levels:

### Normal User

A Normal User only has a Primary Code and is only granted access when the Digy Elite is in Normal or Bypass Mode.

### Secure User

A Secure User must have a Primary and Secondary Code programmed, the two codes must not be the same. The Secure User can gain access when the Digy Elite is in any of its three Modes of Operation. In Normal Mode the Secure User must use their Primary Code to gain entry. In Secure Mode the Secure User must present both their Primary and Secondary Codes in order to gain entry.

### Master User

A Master User must have both Primary and Secondary Codes programmed with the same PIN code. The Master User can gain access during any Mode of Operation by presenting their PIN code to the controller. (The Master User is convenient but is less secure than a Secure User).

## 5. Modes of Operation

The Digy Elite has 3 Modes of Operation:

### 1. Normal Mode

Normal Mode is the default mode

and the Mode LED is green. In

Normal Mode the door is locked

until a Primary Code is presented to the controller. Special codes such as "Open Code" and "Auxiliary Code" are active in Normal mode. (see par. 8 e 9).



2. Bypass Mode.

In Bypass mode the Mode LED is orange. In Bypass Mode, access to the premises is dependent on whether the controller's Lock Strike Relay is programmed for Fail Safe Operation or Fail Secure Operation.



- When the Lock Strike Relay is programmed for Fail Secure Operation, the door is locked until the Door Bell Button is pressed.
- When the Lock Strike Relay is programmed for Fail Safe Operation, the door is constantly unlocked.

3. Secure Mode

In secure mode the LED is red. Only Secure and Master Users can access the premises during the Secured Mode.

A Secure User must enter their Primary and Secondary Codes to gain entry. After entering their Primary Code the Door LED will flash green for 10 seconds, during which the Secondary Code must be entered. A Master User only needs to present their PIN code once to gain entry.



5.1 Changing the Modes of Operation

5.1.1 Changing from Normal Mode to Secure Mode:

The default factory setting for the Normal / Secure Code is 3838.

- Enter the 4-digit Normal / Secure Code. Mode LED will flash red.
- Press the "#" key to confirm the Mode change. Mode LED is red.

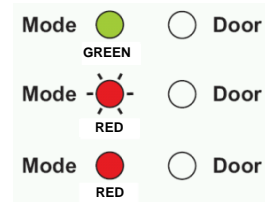

5.1.2 Changing from Secure Mode to Normal Mode:

The default factory setting for the Normal / Secure Code 3838.

- Enter the 4-digit Normal / Secure Code. Mode LED will flash green.
- Press the "#" key to confirm the Mode change. Mode LED will turn green. The Digy Elite Auxiliary Input can also be used to switch the Mode of Operation from Normal to Secure and vice versa. (see par.11).

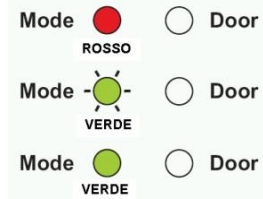

5.1.3 Changing from Normal Mode to Bypass Mode:

To set the Normal/Bypass code refer to par. 12).

- Enter the 4 digit Normal / Bypass Code. Mode LED will flash orange.
- Press the "#" key to confirm the Mode change. Mode LED will turn orange.

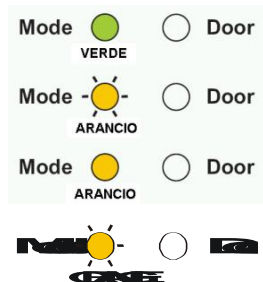

5.1.4 Changing from Bypass Mode to Normal Mode:

To set the Normal/Bypass code refer to par 12.

- Enter the 4 digit Normal / Bypass Code. Mode LED will flash green.
- Press the "#" key to confirm the Mode change. Mode LED will turn green.



## 6. Auxiliary Input and Output

GREEN

The Digy Elite auxiliary input and output can be configured in different combinations, for optimum usability in different applications. (see par.13).

## 7. Request to Exit (REX) Button

The REX button must be located inside the premises to be secured and is used to open the door without the use of a proximity card or PIN code, it is usually located in a convenient location, e.g. Inside the door or at a receptionist's desk. The function of the REX button depends on whether the Lock Strike Relay is programmed for Fail Safe Operation or Fail Secure Operation.

1. Fail Secure Operation: From the moment the REX button is pressed, the door will be unlocked until the "Lock Strike Release Time" has passed. After this time, the door will be locked even if the REX button has not been released.
2. Fail Safe Operation: From the moment the REX button is pressed, the door will be unlocked until the REX button is released, plus the "Lock Strike Release Time". In this case the "Lock Strike Relay" only begins its count down once the REX button has been released.

## 3. Programming the Digy Elite

Programming the Digy Elite is done solely via the unit's keypad driven Programming Menu System (see par.7.1). Certain codes and settings are pre-programmed with Default Factory Settings. The table below shows the names of all the Digy Elite Menus, default factory codes and settings.

Factory settings	Menu description	Menu number	Par.
2580	Change Open Code	1	8
0852	Change Auxiliary Code	2	9
1234	Change Program Code	3	10
3838	Change Normal / Secure Code	4	11
N/A	Change Normal / Bypass Code	5	12
2004	Define Auxiliary Inputs / Outputs	6	13
0004	Change Door Release Time	6	14
	Enroll Proximity Cards, PIN Code or both	7	15
	Delete Proximity Cards Or PIN Code	8	16
	Code Assignment with Strike/Auxiliary	9	17
	Enabling the built-in keypad heater	6	<b>Errore. L'origine riferimento non è stata trovata.</b>
	Return to Default Factory Setting	0	21

### 7.1 Entering Programming Mode

1. Press the "#" key two times. Mode LED will turn off. Door LED will turn red.
2. Enter your 4-digit Programming Code.
3. If the Programming Code is valid the door LED will turn green and the Digy Elite will be in Programming Mode.

#### NOTE

- The Digy Elite must be in Normal Mode to enter the Programming Mode.
- The factory default Programming Code is 1234
- If a Programming Code is not entered within 5 seconds, the Digy Elite will return to Normal Mode.

### 7.2 To exit the Programming Mode

1. Press the " #" key once, you will hear a long beep.
2. The Door LED will be off and the Mode LED will turn green, the Digy Elite has returned to Normal Mode

#### NOTE

- Wrong entries may reset the controller back to Normal Mode.

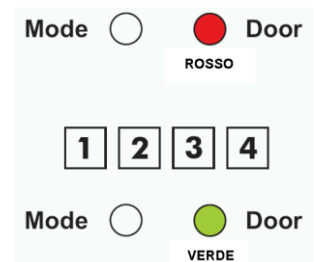

- While in Programming Mode if no key is pressed for 1 minute the Digy Elite will exit programming mode and return to Normal Mode.

## 8. Changing the Open Code

The Open Code is mainly used as a method to quickly test the Lock Strike Relay during installation. The Default Factory Setting for the Open Code is 2580.

When the first user is added to the controller, the default Open Code will automatically be deleted, ready for a new Open Code to be re-entered.

- Enter Programming Mode
- Press "1" to enter Menu 1. The Mode LED will turn red.
- Enter the new 4-digit code you wish to set as Open Code.
- The Digy Elite returns to Normal Mode: the Door LED will turn off and the Mode LED will turn green.

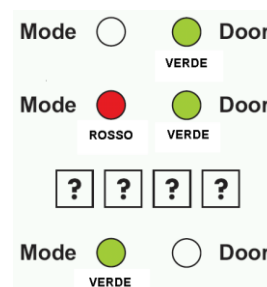

### NOTE

- Open Code does not function in Secure Mode.
- Wrong entries will return the controller to Normal Mode.
- Code 0000 will erase and deactivate the Open Code.

## 9. Changing the Auxiliary Code

The Auxiliary Code is mainly used as a method to quickly test the Auxiliary Relay during installation. The Default Factory Setting for the Auxiliary Code is 0852.

When the first user is added to the controller, the default Auxiliary Code will automatically be deleted, ready for a new Auxiliary Code to be re-entered.

- Enter Programming Mode
- Press "2" to enter Menu 2. The Mode LED will turn orange
- Enter the new 4-digit code you wish to set as Auxiliary Code
- The Digy Elite returns to Normal Mode: you will hear three beeps. The Door LED will turn off and the Mode LED will turn green

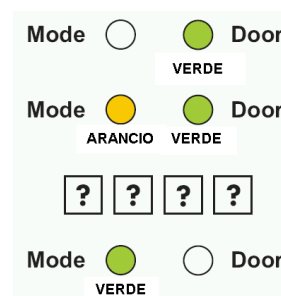

### NOTE

- Auxiliary Code does not work in Secure Mode.
- Auxiliary Code only works when the Auxiliary Mode is 1 or 2.
- Code 0000 will erase and deactivate the Auxiliary Code.

## 10. Changing the Programming Code

- Enter Programming Mode.
- Press "3" to enter Menu 3: the Mode LED will turn green
- Enter the new 4-digit code you wish to set as Programming Code
- The Digy Elite returns to Normal Mode: the Door LED will turn off and the Mode LED will turn green

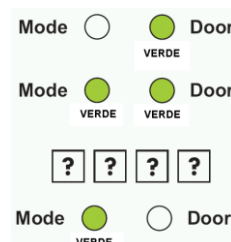

### NOTE

- Programming Code can not be erased, i.e. the code 0000 is not valid and will not erase the Programming Code.

### 11. Changing the Normal / Secure Code

1. Enter Programming Mode
2. Press "4" to enter Menu 4: the Mode LED will flash red.
3. Enter the new 4-digit code you wish to set as Normal / Secure Code
4. The Digy Elite returns to Normal Mode: The Door LED will turn off and the Mode LED will turn green.

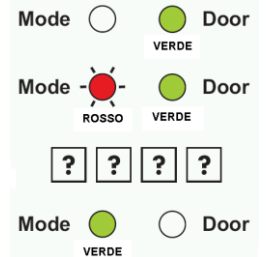

**NOTE**

When the Auxiliary Mode is 1, 2, 3, or 4 the Auxiliary Input takes priority over the Normal / Secure Code.

### 12. Changing the Normal / Bypass Code

5. Press "5" to enter Menu 5: the Mode LED will flash orange.
6. Enter the 4-digit code (different to 0001) to enable Bypass Code. To disable Bypass Code enter the 4-digit code 0000.
7. The Digy Elite returns to Normal Mode: the Door LED will turn off and the Mode LED will turn green.

### 13. Defining Auxiliary Inputs/Outputs

1. Enter Programming Mode.
2. Press "6" to enter Menu 6: the Mode LED will flash green.
3. Construct the 4-digit code using the instructions below

Digy Elite returns to Normal Mode: The Door LED will turn off and the Mode LED will turn green.

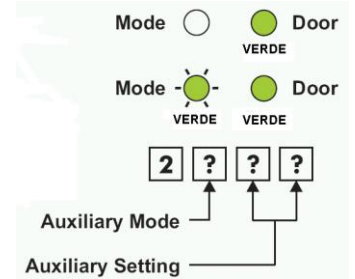

Auxiliary Mode	Auxiliary Input	Auxiliary Output Activated On	Aux. Relay	Time Settings	
				(All times and delay are in seconds)	
0	REX-2	Valid Code or REX-2	N.O.	01 to 99 00	Aux. Relay Release Time Aux. Relay Toggles
1	Normal / Secure	Valid Code	N.O.	01 to 99 00	Aux. Relay Release Time Aux. Relay Toggles
2	Normal / Secure	Bell Button (*)	N.O.	01 to 99 00	Aux. Relay Release Time Aux. Relay Toggles
3	Normal / Secure	Tamper Event	N.C.	01 to 99 00	Aux. Relay Release Time Aux. Relay activated by Tamper
4	Normal / Secure	Direct Shunt	N.O.	00 to 99	Shunt time
5	Door Monitor	Shunt	N.C.	00 to 99	Maximum Shunt Time
6	Door Monitor	Forced Door	N.C.	00 to 99	Forced Delay
7	Door Monitor	Door Ajar	N.C.	00 to 99	Ajar Delay
8	LED Ctrl – Red	Valid code	N.O.	01 to 99 00	Aux relay release time Aux relay toggle
9	LED Ctrl – Green	Valid code	N.O.	01 to 99 00	Aux relay release time Aux relay toggle

## 14. Setting Fail Safe/Secure Operation and Lock Strike Release Time

1. Enter Programming Mode
2. Press "6" to enter Menu 6: the Mode LED will flash green.
3. Construct the 4-digit code using the instructions below:

First Digit: **0** for Fail Secure, **1** for Fail Safe

Second Digit: **0**.

Third and Fourth Digit: Lock Strike Time, enter 1 to 99 seconds

For example: **0 0 1 2** means: Fail Secure Operation, with a 12 second Lock Strike release time.

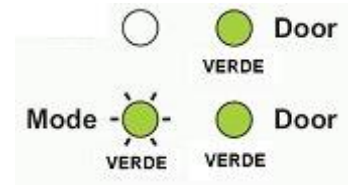

## 15. Enrolling Primary & Secondary Codes

### Primary Codes

- Primary Codes can only be enrolled to an empty User Slot, i.e. a slot where there is no existing Primary Code.
- Primary Codes must be unique, i.e. one users Primary Code may not be the same as another users Primary Code.
- Primary Codes cannot be the same as any system codes, such as the Normal / Secure Code or Open Code.
- Users who hold a Primary Code can gain entry only during Normal Mode.

### Secondary Codes

- Secondary Codes can only be enrolled to User Slot that already has a Primary Code enrolled but no Secondary Code.
- Secondary Codes do not have to be unique, i.e. multiple users can all hold the same Secondary Code.
- Secondary Codes cannot be the same as any system codes, such as the Normal / Secure Code or Open Code.
- Users who hold Secondary Codes can gain entry in any Mode of Operation.

### Enrolling codes

There are two methods to enroll Primary and Secondary codes, the Standard Method and the Code Search Method.

- A. The Standard Method is mainly used when the User Slot number for the user you wish to program is known. You can program both Primary and Secondary Codes using the Standard method.

The Code Search Method is mainly used when enrolling a users Secondary Code and the User Slot Code is unknown. The Code Search method only works if a user's Primary Code is already enrolled but the Secondary Code is not.

### 15.1 Enrolling Primary and Secondary Codes using the Standard Method

1. Enter Programming Mode.
2. Press "7" to enter Menu 7: the Door LED will turn orange.
3. Enter the 3-digit User Slot number between 001 to 500 that you wish to enroll a Primary or Secondary code to. (For example, the User Slot 003 represents User #3).

- If the selected slot has no Primary Code, the Mode LED will flash green, indicating that the controller is ready to accept a Primary Code.
- If the selected slot already has a Primary Code but no Secondary Code, the Mode LED will flash red, indicating that the controller is ready to accept a Secondary Code.
- If the selected slot already has a Primary and Secondary Code, you will hear a long beep and the controller will return to Normal Mode.

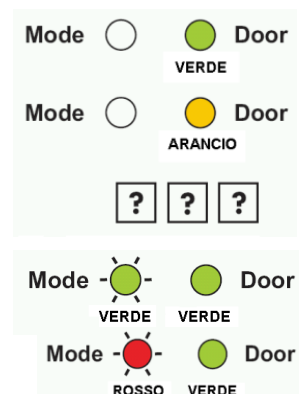

4. Enter the 4-digit PIN that you want to assign as the Primary or Secondary Code for this slot number. If the PIN that is entered is valid the Mode LED will stop flashing and then the controller is ready for you to enter the next 3 Digit slot number (refer to step 3) that you want to assign a code to.
5. press the "#" key to move to the next slot number (refer to step 4). If you do not wish to continue enrolling codes, press the "#" key twice and the controller will return to Normal Mode.



## 15.2 Enrolling Secondary Codes using the Code Search Method

1. Enter Programming Mode
2. Press "7" to enter Menu 7: the Door LED will turn Orange
3. Enter the 3-digit User Slot number **000**, the Door LED will flash Orange: the controller is now waiting for the Primary Code of the User you want to add a Secondary Code to.
4. Enter the 4 Digit PIN Code of the Primary Code: the Mode LED will flash red (If the Primary Code entered is not valid, you will hear a long beep and the Digy Elite will continue to wait for a valid Primary Code).
5. Enter the 4-digit PIN Code to be used as the Secondary Code., If the Secondary Code is valid the controller will beep three times and return to Normal Mode. (If the Secondary Code is invalid the controller will make a long beep and then the Digy Elite will continue to wait for a valid Secondary code to be entered).

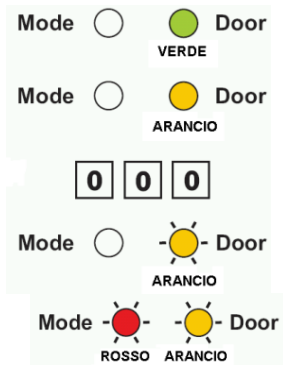

## 16. Deleting Primary & Secondary Codes

There are two methods to delete Primary and Secondary codes, the Standard Method and the Code Search Method. When deleting a User Slot, both the Primary Code and the Secondary code are erased.

### 16.1 Deleting Primary and Secondary Codes using the Standard Method

1. Enter Programming Mode.
2. Press "8" to enter Menu 8: the Mode LED will turn red.
3. Enter the 3-digit User Slot codes you wish to delete: The Mode LED will flash red indicating the controller is waiting for the Programming Code to confirm the deletion. If the User Slot is empty you will hear a long beep and the Digy Elite will return to Normal Mode.
4. Enter your Programming Code to confirm the deletion: If the Programming Code is valid, you will hear three beeps and the Digy Elite will return to Normal Mode (If the Programming Code is invalid, you will hear a long beep and the Digy Elite will return to Normal Mode).

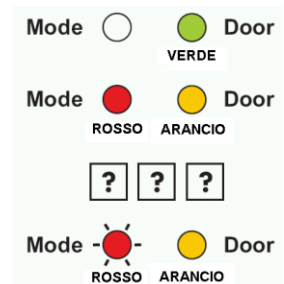

### 16.2 Deleting Primary and Secondary Codes using the Code Search Method

1. Enter Programming Mode.
2. Press "8" to enter Menu 8: the Mode LED will turn red.
3. Enter the 3-digit User Slot 000: the Door LED will flash orange.
4. Enter the 4-digit PIN Code of the Primary Code belonging to the user you want to delete: the Mode LED will flash red (if the PIN Code is invalid, you will hear a long beep and the Mode LED will not flash).
5. Enter your Programming Code to confirm the deletion: If the Programming Code is valid, you will hear three beeps and the Digy Elite will return to Normal Mode (If the Programming Code is invalid, you will hear a long beep and the Digy Elite will return to Normal Mode).

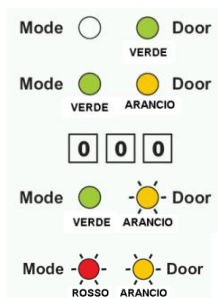

## 17. Lock Strike Relay and Auxiliary Relay Code Assignment using the Standard Method

When a Primary Code is enrolled for any user, that user is assigned rights to activate the Lock Strike Relay when they present a valid code to the controller. The Code Assignment Menu allows you to assign whether the Lock Strike Relay and/or the Auxiliary Relay is activated when a user enters a valid code. There are two methods to Assign Codes, Standard Method and the Code Search Method.

## 17.1 Relay Code Assignment using the Standard Method

1. Enter Programming Mode
2. Press "9" to enter Menu 9: the Mode LED will turn green.
3. Enter the 3-digit User Slot that you want to assign a code to: The Mode LED will flash green.
4. Enter the assignment digit for the current User Slot:
  - "1" assigns the Lock Strike Relay only
  - "2" assigns the Auxiliary Strike Relay only
  - "3" assigns the Lock Strike and Auxiliary Relay
5. If the assignment code is valid the Mode LED will stop flashing and the Digny Elite is now waiting for another slot number. Press the "#" key to go to the next slot, press the "#" key twice to return to Normal Mode.

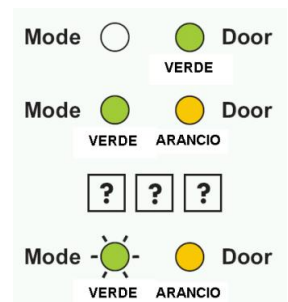

## 17.2 Relay Code Assignment using the Code Search Method

1. Enter Programming Mode
2. Press "9" to enter Menu 9: The Mode LED will turn green.
3. Enter the 3-digit User Slot 000: The Door LED will flash orange.
4. Enter the 4-digit PIN Code of the Primary Code belonging to the user you want to assign a code to: The Mode LED will flash green.
5. Enter the assignment digit for the current User Slot:
  - "1" assigns the Lock Strike Relay only
  - "2" assigns the Auxiliary Strike Relay only
  - "3" assigns the Lock Strike and Auxiliary Relay
6. If the assignment digit is valid the LED 'Mode' will stop flashing and the Digny Elite is now waiting for another slot number. Press the "#" key to go to the next slot, press the "#" key for 2 seconds to return to Normal Mode.

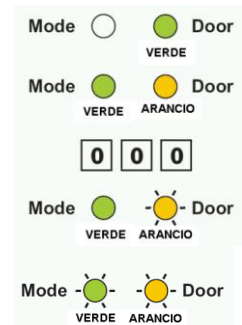

## 18. Enabling or Disabling the built-in keypad heater

The Digny Elite contains a built-in keypad heater. When is enabled the keypad heater will activate when the ambient temperature drops to approx. 3 C to 5 C and will remain active until the keypad temperature rises to approx 5 C to 8 C.

When the heater is enabled the Digny Elite is lowest operating temperature is -20 C, otherwise is 0°C; When the built-in keypad heater is active it will require additional power.

The factory default setting for the keypad heater is disabled, to changing it:

1. Enter Programming Mode.
2. Press "6" to enter Menu 6: the Mode LED will flash green.
3. Construct the digit code **3 0 0** and the fourth digit as follows:
  - "0" to DISABLE the heater
  - "1" to ENABLE the heater

## 19. Replacing a lost Programming Code

**NOTE:** The Digny Elite must be in Normal Mode otherwise this will not work. Make sure that the Mode LED is green before proceeding

1. Remove power
2. Press the REX button
3. Apply power to the unit with REX button pressed
4. Release the REX button
5. Within 15 seconds enter programming mode by pressing # twice (see point 11), enter the standard programming code 1 2 3 4
6. Press 3 to access the programming code modification function
7. Enter the new programming code.
8. The Digny Elite returns to Normal mode: the 'Door' LED switches off and the 'Mode' LED turns green.

## 20. Replacing a lost Normal / Secure Code

**NOTE:** The Digy Elite must be in Secure Mode otherwise this will not work. Make sure that the Mode LED is red before proceeding.

1. Remove power
2. Press the REX Button
3. Apply power to the unit with REX button pressed

Release the REX Button

4. You now have 15 seconds to use the default Normal/Secure Code 3838 in order to return to normal mode, where you may enter programming mode and enter a new Normal/ Secure Code

## 21. Return To Factory Default Settings

### Warning:

**You must be very careful before using this command! Doing so will erase the entire memory which includes all User and Special Codes, and return all codes to their factory default settings.**

1. Enter Programming Mode
2. Press "0" to enter Menu 0: both LEDs flash red.
3. Enter your 4-digit Programming Code: If the Programming Code is valid, all memory will be erased, you will hear three beeps and the controller will return to Normal Mode (If the Programming Code is invalid you will hear a long beep and the controller will return to Normal Mode without erasing the memory of the controller).

**Note:** if the programming code is misplaced, follow the procedure described in section 20 before restoring factory settings.

